

VOLUMEN (l)  
VOLUMEN (l)

MAX. OBREMENITEV (kg)  
MAX. OBTEREČENJE (kg)

OBREMENITEV TAL (kg/m<sup>2</sup>)  
OBTEREČENJE PODA (kg/m<sup>2</sup>)

230

360

285





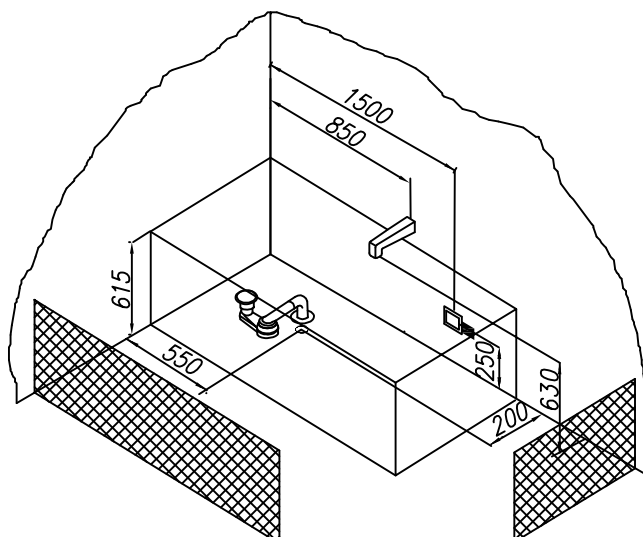



- – Prostor za el. vodnik 3 x 1,5 mm<sup>2</sup> dolžine cca 1m.
- – Mjesto za el. vodnik 3 x 1,5 mm<sup>2</sup> dužine cca 1m.
- – Prostor za el. vodnik 1 x 6 mm<sup>2</sup> za ozemljitev, dolžine cca 1,5m.
- – Mjesto za el. vodnik 1 x 6 mm<sup>2</sup> za ozemljenje, dužine cca 1,5m.
- – Prostor za odtok Ø 50 mm
- – Mjesto za odtok Ø 50 mm
- ▨ – Opcija-obloga
- ▨ – Opcija-obloga

PREDLOG VGRADNJE  
PRIJEDLOG UGRADNJE



Tamia 170x75

POLOŽAJ STIKAL IN AGREGATOV PRI RAZLIČNIH IZVEDBAH MASAŽNIH SISTEMOV  
MJESTO PREKIDAČA I AGREGATA KOT RAZLIČITI IZVEDBI MASAŽNIH SISTEMA

- |  |  |   |  |  |
|--|--|---|--|--|
|  - VODNA ČRPALKA<br>- CRPKA ZA VODU        |  - VODNE ŠOBE<br>- VODENE MLAZNICE  |  - REGULATOR ZRAKA<br>- REGULATOR ZRAKA        |  - ELEKTRONSKA STIKALA<br>- ELEKTRONSKI PREKIDAČI         |  - ARMATURA IN TUŠ ROČICA<br>- PIPA I TUŠ                 |
|  - ZRAČNI KOMPRESOR<br>- ZRAČNI KOMPRESOR |  - ZRAČNA ŠOBA<br>- ZRAČNA MLAZNICA |  - PNEVMATSKO STIKALO<br>- PNEVMATSKI PREKIDAČ |  - LUČ ALI CHROMOTERAPIJA<br>- SVJETLO ILI CHROMOTERAPIJA |  - PREKLOPNIK ZA MIKROŠOBE<br>- PREKIDAČ ZA MIKROMLAZNICE |

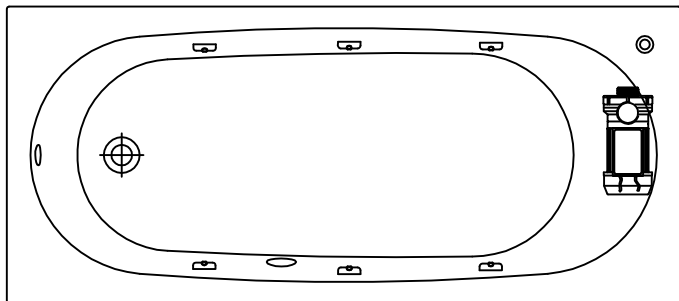

VODNI MASAŽNI SISTEM Q-LINE

- VODNA ČRPALKA  $P= 0,55$  KW
- PNEVMATSKO STIKALO
- 6 VODNIH ŠOB

VODENI MASAŽNI SISTEM Q-LINE

- CRPKA ZA VODU  $P= 0,55$  KW
- PNEVMATSKI PREKIDAČ
- 6 MLAZNICA ZA VODU