

**PREDINSTALACIJA
PREDINSTALACIJA**

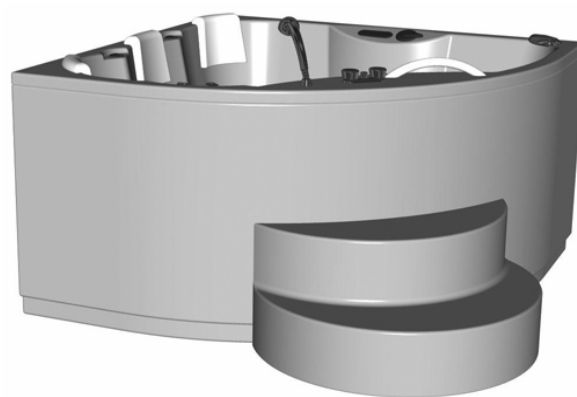
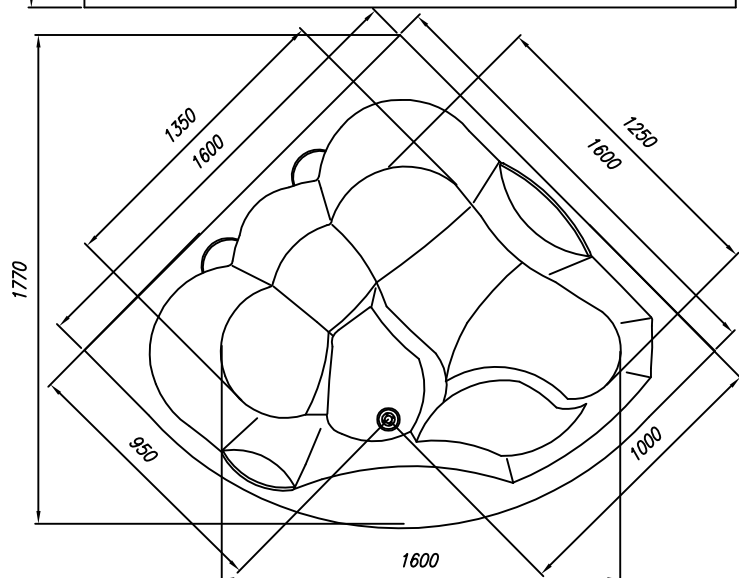
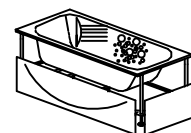
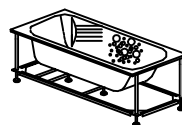
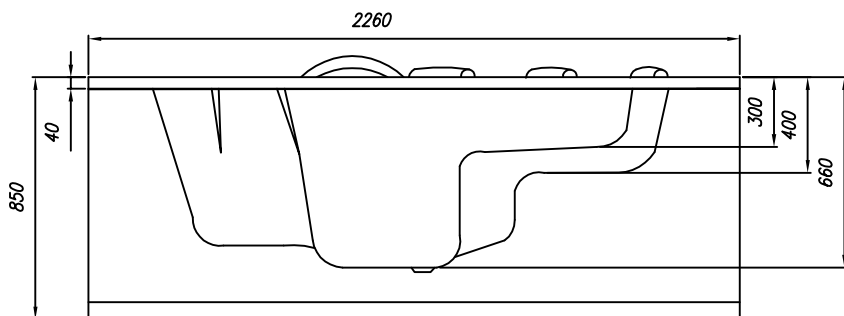

VOLUMEN (l)
VOLUMEN (l)

MAX. OBREMENITEV (Kg)
MAX. OBTEREČENJE (Kg)

OBREMENITEV TAL (Kg/m²)
OBTEREČENJE PODA (Kg/m²)

550

960

340

- - Prostor za el.vodnik 4x4mm²(HO5W-F),(400V,2x20A/L1,L2,N,⊕),oz 3x4mm²(230V,32A/L,N,⊕); L=2,5m
- - Mjesto za el.vodnik 4x4mm²(HO5W-F),(400V,2x20A/L1,L2,N,⊕), odnosno 3x4mm²(230V,32A/L,N,⊕); L=2,5m
- - Prostor za el. vodnik 1 x 6 mm² za ozemljitev, dolžine cca 2,5m.
- - Mjesto za el. vodnik 1 x 6 mm² za ozemljenje, dužine cca 2,5m.



- Priklop tople in hladne vode 1/2" min 2 max 4 bar
- Priključak tople i hladne vode 1/2" min 2 max 4 bar



- Prostor za odtok ø 50 mm
- Mjesto za odtok ø 50 mm



- Opcija-obloga
- Opcija-obloga

PREDLOG VGRADNJE
PRIJEDLOG UGRADNJE

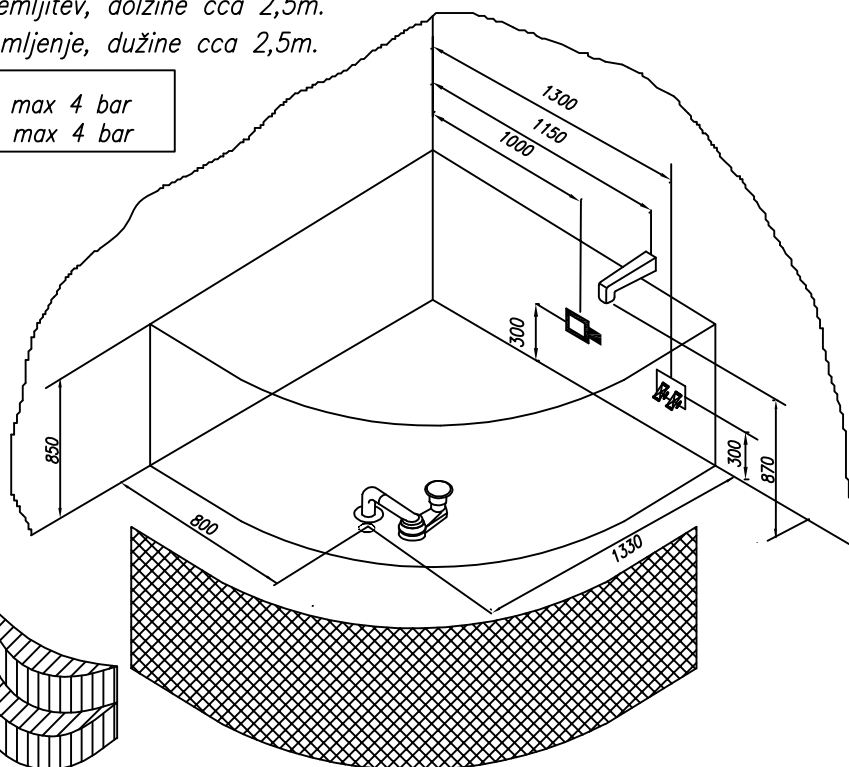

- Opcija-

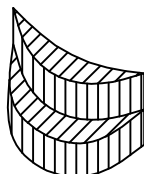

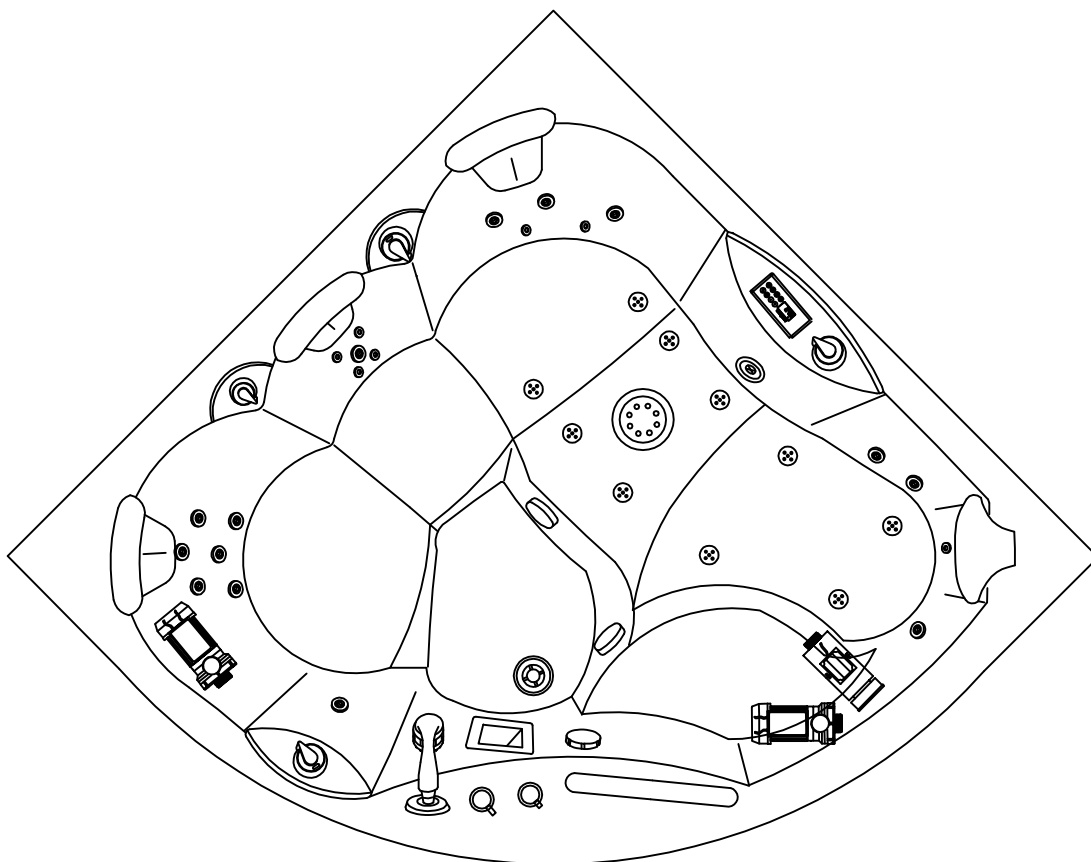
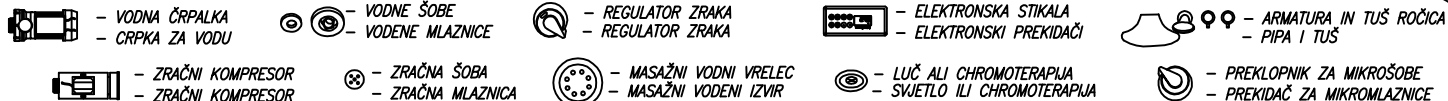
LUXUS+ MASAŽNI SISTEM

- VODNA ČRPALKA P= 1,5 KW
- VODNA ČRPALKA P=1,5 KW
- ZRAČNI KOMPRESOR P=1,05 KW
- GRELEC VODE P=3,6 KW
- 7 VODNIH MIKRO ŠOB
- 11 VODNIH ŠOB SUPER
- 10 ZRAČNIH ŠOB
- CHROMOTHERAPIJA
- OZONATOR
- ARMATURA IN TUŠ ROČICA
- FILTRACIJA VODE
- 3 VRTEČE VODNE ŠOBE
- MASAŽNI VODNI VRELEC

- OPCIJA BATHRELAX
- OPCIJA STOPNICA - AKRIL

LUXUS+ MASAŽNI SISTEM

- ČRPKA ZA VODU P=1,5 KW
- ČRPKA ZA VODU P=1,5 KW
- ZRAČNI KOMPRESOR P=1,05KW
- GRJAC VODE P=3,6 KW
- 7 MIKRO MLAZNICA ZA VODU
- 11 MLAZNICA ZA VODU SUPER
- 10 ZRAČNIH MLAZNICA
- CHROMOTHERAPIJA
- OZONATOR
- PIPA I TUŠ
- FILTRACIJA VODE
- 3 ROTACIJSKE MLAZNICE
- MASAŽNI VODNI IZVIR

- OPCIJA BATHRELAX
- OPCIJA STEPENICA - AKRIL