

VOLUMEN (l)
VOLUMEN (l)

MAX. OBREMENITEV (Kg)
MAX. OBTEREČENJE (Kg)

OBREMENITEV TAL (Kg/m²)
OBTEREČENJE PODA (Kg/m²)

220





360

245

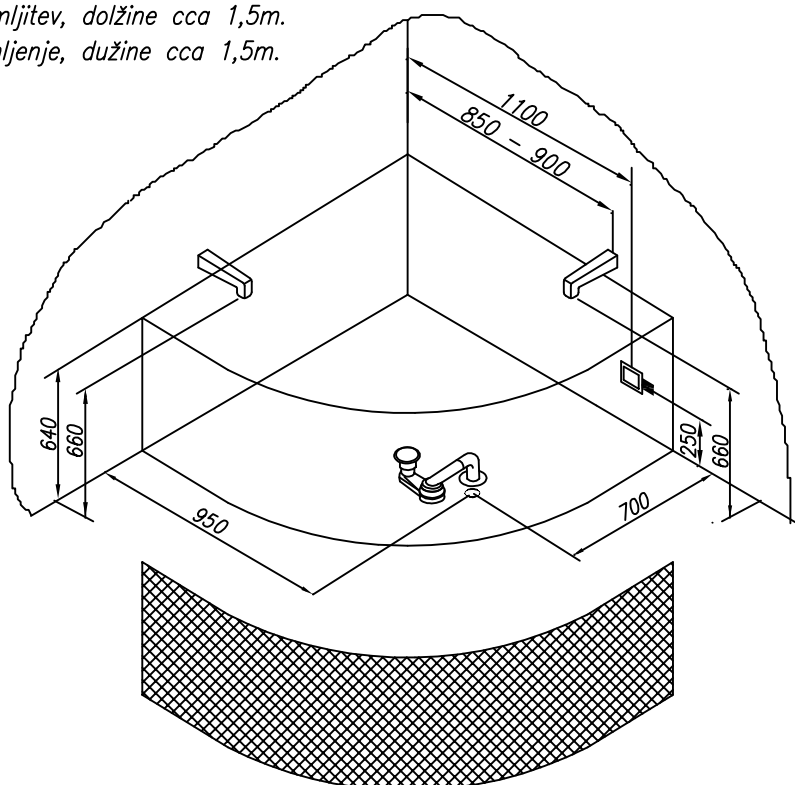
- - Prostor za el. vodnik 3 x 1,5 mm², oziroma 3x2,5 mm² za kombinirane sisteme dolžine cca 1m.
- - Mjesto za el. vodnik 3 x 1,5 mm², odnosno 3x2,5 mm² za kombinirane sisteme dužine cca 1m.
- - Prostor za el. vodnik 1 x 6 mm² za ozemljitev, dolžine cca 1,5m.
- - Mjesto za el. vodnik 1 x 6 mm² za ozemljenje, dužine cca 1,5m.
- - Prostor za odtok ø 50 mm
- - Mjesto za odtok ø 50 mm
- ▣ - Opcija-obloga
- ▣ - Opcija-obloga

PREDLOG VGRADNJE
PRIJEDLOG UGRADNJE



- | | | | | |
|---|--|---|--|--|
|  - VODNA ČRPALKA
- CRPKA ZA VODU |  - VODNE ŠOBE
- VODENE MLAZNICE |  - REGULATOR ZRAKA
- REGULATOR ZRAKA |  - ELEKTRONSKA STIKALA
- ELEKTRONSKI PREKIDAČI |  - ARMATURA IN TUŠ ROČICA
- PIPA I TUŠ |
|  - ZRAČNI KOMPRESOR
- ZRAČNI KOMPRESOR |  - ZRAČNA ŠOBA
- ZRAČNA MLAZNICA |  - PNEVMATSKO STIKALO
- PNEVMATSKI PREKIDAČ |  - LUČ ALI CHROMOTERAPIJA
- SVJETLO ILI CHROMOTERAPIJA |  - PREKLOPNIK ZA MIKROŠOBE
- PREKIDAČ ZA MIKROMLAZNICE |

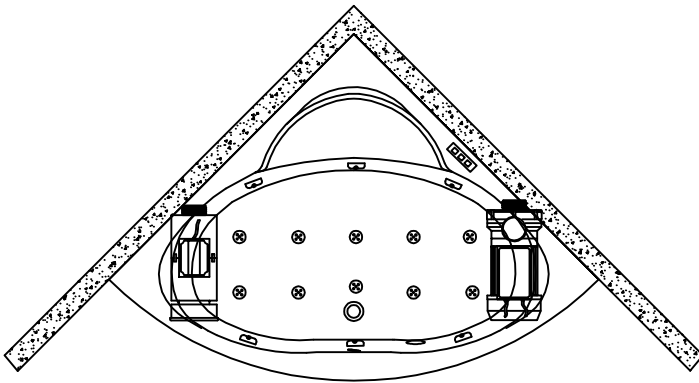
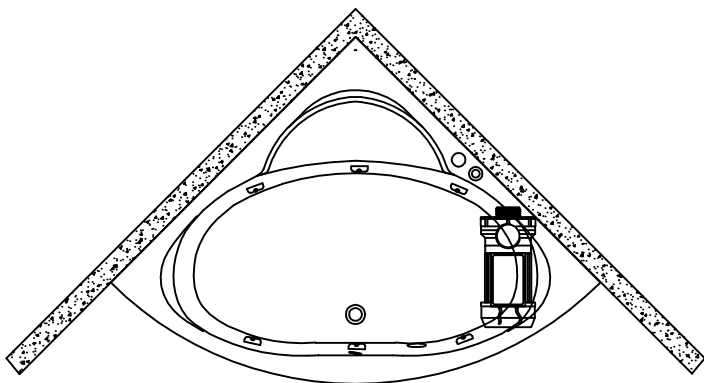

VODNI MASAŽNI SISTEM

- VODNA ČRPALKA P= 0,8 KW
- PNEVMATSKO STIKALO
- 6 VODNIH ŠOB
- REGULATOR ZRAKA

VODNI MASAŽNI SISTEM

- CRPKA ZA VODU P= 0,8 KW
- PNEVMATSKI PREKIDAČ
- 6 MLAZNICA ZA VODU
- REGULATOR ZRAKA

VODNI IN ZRAČNI
MASAŽNI SISTEM

- VODNA ČRPALKA P= 0,8 KW
- ZRAČNI KOMPRESOR P=0,8KW
- ELEKTRONSKO STIKALO
- 6 VODNIH ŠOB
- 10 ZRAČNIH ŠOB

VODNI, I ZRAČNI
MASAŽNI SISTEM

- CRPKA ZA VODU P= 0,8 KW
- ZRAČNI KOMPRESOR P=0,8KW
- ELEKTRONSKI PREKIDAČ
- 6 MLAZNICA ZA VODU
- 10 ZRAČNIH MLAZNICA

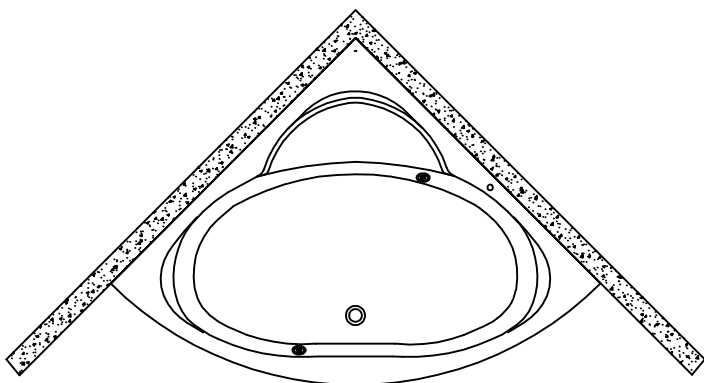

- OPCIJA BATHRELAX
- OPCIJA CHROMOTHERAPIJA

- OPCIJA BATHRELAX
- OPCIJA CHROMOTHERAPIJA